



 **Home Comfort**  
Work In Style • Live In Comfort

c a t a l o g u e | o f f i c e f u r n i t u r e

# C O N T E N T S

## OFFICE DESKS

# 02

SENRO TABLES	02
SENRO CABINETS	08
SENRO WORKSTATION	09
SENRO RECEPTIONS	10
SENRO CONFERENCE	12
ID OFFICE DESKS	14
ID CONFERENCE	16
BEEMAG OFFICE DESKS	18
BEEMAG CONFERENCE	22
BEEMAG RECEPTIONS	26
BEEMAG L-SHAPE TABLES	28
WORKSTATION CONCEPTS	32
BANQUET TABLES	33

## STEEL SERIES

# 34

STEEL CABINETS	34
METAL SHELVES	37
MOBILE COMPACTOR	39

## CHAIRS

# 40

BONGE SERIES	40
NANA SERIES	42
PRESIDENTIAL SERIES	44
MIMOSA SERIES	46
TIMORO SERIES	48
DEX SERIES	50
AERON ORTHOPAEDIC	52
TUNE ORTHOPAEDIC	54
RIMOVA ERGONOMIC	56
LEGO ERGONOMIC	58
HUGO SERIES	60
LONG ERGONOMIC	62
DELUXE ERGONOMIC	64
SIGMA SERIES	66
YEBA SERIES	68
SUPREMO SERIES	70
VOGUE SERIES	72
SOLO SERIES	74
OPTIMA SERIES	76
ACCENT SERIES	78
BENO SERIES	80
BUMA SERIES	82
MAX SERIES	84
NEVO SERIES	86



2 years warranty on  
Parts & Accessories



Free prompt deliveries  
within Arusha region



On-site free installation  
and maintenance



Expertise of over 21  
years in business



Our specialists work  
closely with you providing  
you with expert advice



We help you in shifting  
your furniture to your  
new office

**SENRO**  
SERIES

EXECUTIVE TABLES





**CM 88**  
**TABLE** : W2200 X D2070 X H750  
**COLOR** : Dark Walnut & Iron Grey



**AD 22115**  
**TABLE** : W2200 X D2070 X H810  
**COLOR** : Dark Walnut & Iron Grey



**AD 18136**  
**TABLE** : W1800 X D1490 X H750  
**COLOR** : Dark Walnut & Iron Grey



**AD 18113**  
**TABLE** : W1800 X D1600 X H750  
**COLOR** : Dark Walnut & Iron Grey



**AD 14118**  
**TABLE** : W1400 X D700 X H750  
**COLOR** : Dark Walnut & Iron Grey

**MATERIAL**  
 Engineered MDF with  
 Smooth melamine finish,  
 Non-deformation material.



\* ALL DIMENSIONS IN MM

SENRO  
SERIES





**AD 22160**  
**TABLE** : W2200 X D1960 X H750  
**COLOR** : Brown Oak + Brown



**AD 22115**  
**TABLE** : W2200 X D1900 X H750  
**COLOR** : Brown Oak + Brown



**AD 20100**  
**TABLE** : W2000 X D1600 X H750  
**COLOR** : Brown Oak + Brown



**AD 18136**  
**TABLE** : W1800 X D1490 X H750  
**COLOR** : Brown Oak + Brown



**AD 18162**  
**TABLE** : W1800 X D1600 X H750  
**COLOR** : Brown Oak + Brown

**CABLE GROMMETS**  
 Cable management grommets with brush for clean and tear free cable organizer



\* ALL DIMENSIONS IN MM



SENRO  
SERIES





**AD 16162**  
**TABLE** : W1600 X D800 X H750  
**COLOR** : Brown Oak + Brown



**AD 14118**  
**TABLE** : W1400 X D700 X H750  
**COLOR** : Brown Oak + Brown



**AD 15163**  
**TABLE** : W1500 X D700 X H750  
           : W1200 X D700 X H750  
**COLOR** : Brown Oak + Brown



**AD 14120**  
**TABLE** : W1400 X D700 X H750  
**COLOR** : Brown Oak + Brown

**CABLE GROMMETS**  
 Cable management grommets with brush for clean and tear free cable organizer





**AF 0811**  
**CABINET** : W1600 X D400 X H2000  
**COLOR** : Brown Oak & Brown  
 : Dark Walnut & Iron Grey



**AF 08113**  
**CABINET** : W800 X D400 X H2000  
**COLOR** : Brown Oak & Brown  
 : Dark Walnut & Iron Grey



**CB 88-16**  
**CABINET** : W1600 X D400 X H2000  
**COLOR** : Brown Oak & Brown  
 : Dark Walnut & Iron Grey



**CB 88-08**  
**CABINET** : W800 X D400 X H2000  
**COLOR** : Dark Walnut & Iron Grey



**MATERIAL**  
 Engineered MDF with Smooth melamine finish,  
 Non-deformation material.



**CB 85-12**  
**CABINET** : W1200 X D400 X H800  
**COLOR** : Dark Walnut & Iron Grey  
 Brown Oak & Brown

\* ALL DIMENSIONS IN MM

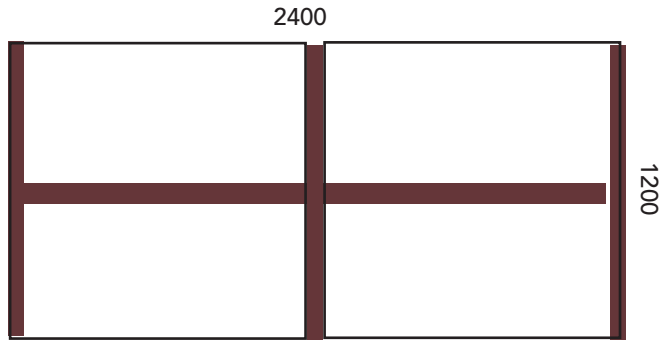

DIMENSION: W2400 x D1220 x H1150 mm



DIMENSION: W2400 x D1200 x H1050 mm

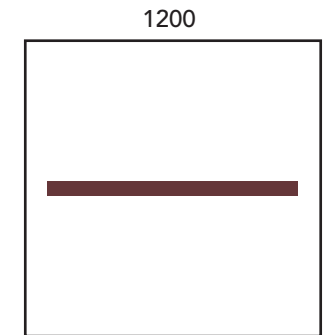

\* ALL DIMENSIONS IN MM

SENRO  
SERIES

RECEPTIONS



 **Home Comfort**  
Work In Style • Live In Comfort



**CR 71-19**  
**TABLE** : W1900 X D666 X H1050  
**COLOR** : Dark Walnut & Warm White



**CR 86-24**  
**TABLE** : W2400 X D600 X H1050  
 : W1800 X D600 X H1050  
**COLOR** : Dark Walnut & Iron Grey  
 Brown Oak & Brown



**GR-24169**  
**TABLE** : W2400 X D800 X H1000  
**COLOR** : Dark Walnut, Warm White & Iron Grey



**AR 12-02**  
**TABLE** : W1200 X D725 X H1150  
**COLOR** : Brown Oak & Brown

\* ALL DIMENSIONS IN MM

**SENRO**  
SERIES

MEETING TABLES





**CCF 82-36**  
**TABLE** : W3600 X D1400 X H750  
**COLOR** : Dark Walnut & Iron Grey  
 Brown Oak & Brown



**CCF 82-24**  
**TABLE** : W2400 X D1200 X H750  
**COLOR** : Dark Walnut & Iron Grey  
 Brown Oak & Brown



**GCF 1068**  
**TABLE** : W1000 X D1000 X H750  
**COLOR** : Dark Walnut & Iron Grey  
 Brown Oak & Brown



**GCF 18-22**  
**TABLE** : W1800 X D900 X H750  
**COLOR** : Brown Oak & Brown

\* ALL DIMENSIONS IN MM

ID  
SERIES

OFFICE TABLES





**Writing Table**  
 ID 1280 1200 x 800 x 750  
 ID 1480 1400 x 800 x 750  
 ID 1680 1600 x 800 x 750

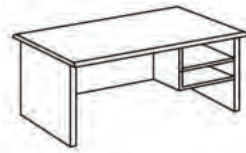

**Side Return With Open Shelf**  
 ID 1045 (OS) 1000 x 450 x 690

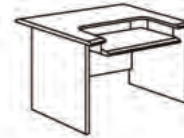

**Computer Table**  
 ID CT800 800 x 800 x 750

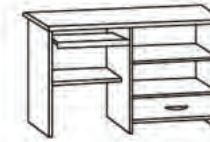

**Computer & Printer Table**  
 ID CPT1280 1200 x 800 x 750



**Round Conference Table**  
 ID R90 900 x 900 x 750  
 ID R120 1200 x 1200 x 750



**Open Shelf Cabinet**  
 ID 888O 800 x 400 x 825



**Pigeon Hole Cabinet**  
 ID 888P 800 x 400 x 825



**Swinging Door Cabinet**  
 ID 888W 800 x 400 x 825

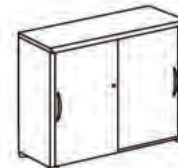

**Sliding Door Cabinet**  
 ID 888S 800 x 400 x 825



**Filing Cabinet**  
 ID 840W 800 x 400 x 1975

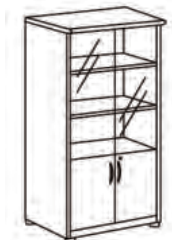

**Bookshelf With Magnetic System**  
 ID 840 800 x 400 x 1975

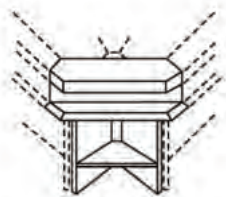

**Counteriser With Connection Top**  
 ID CCR80 1200 x 600 x 1040  
 (Black Only)

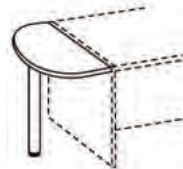

**Conference Connection Top With Steel Leg**  
 ID CCNT1200 (SL) 1200 x 600 x 750  
 (Black Only)

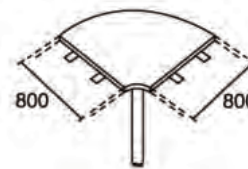

**Round Connection Top With Steel Leg**  
 ID CNT80 800 x 800 x 750  
 (Black Only)

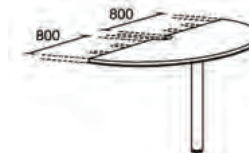

**Conference Connection Top With Steel Leg**  
 ID CCNT1760(SL) 1700 x 600 x 750  
 (Black Only)

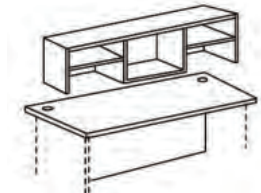

**Counter Top**  
 ID CT1280 1200 x 300 x 285  
 ID CT1480 1400 x 300 x 285  
 ID CT1680 1600 x 300 x 285



**Coffee Table**  
 ID CFT45 450 x 450 x 425



**Coffee Table**  
 ID CFT90 900 x 450 x 425



**Fixed Pedestal**  
 ID FP(3D) 400 x 470 x 445



**Mobile Pedestal**  
 ID MP(3D) 415 x 490 x 560



**CPU Trolley**  
 ID CPU480 250 x 480 x 300



**Plastic Keyboard Tray**  
 ID KBT-P 550 x 270 x 35

\* ALL DIMENSIONS IN MM

ID  
SERIES

MEETING TABLES



**1200MM TABLE**

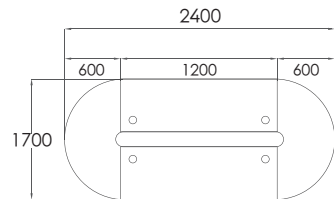

W2400 X D1700 X H760

**1400MM TABLE**

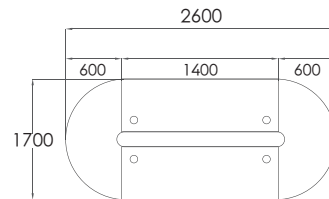

W2600 X D1700 X H760

**1600MM TABLE**

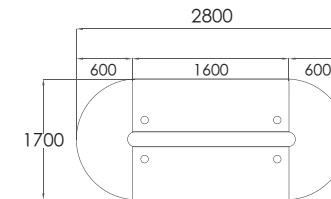

W2800 X D1700 X H760

**3600**

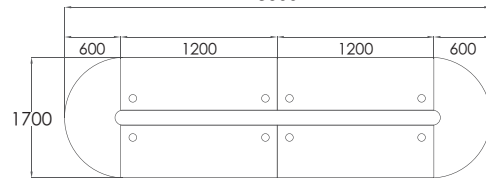

W3600 X D1700 X H760

**4000**

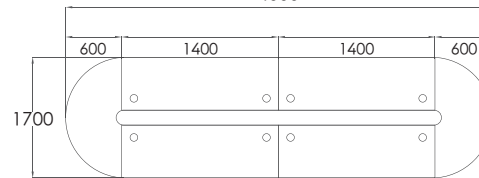

W4000 X D1700 X H760

**4400**

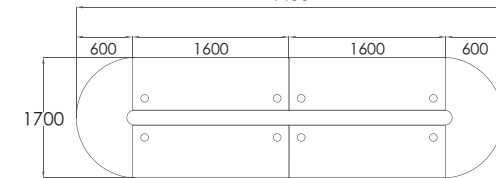

W4400 X D1700 X H760

**4800**

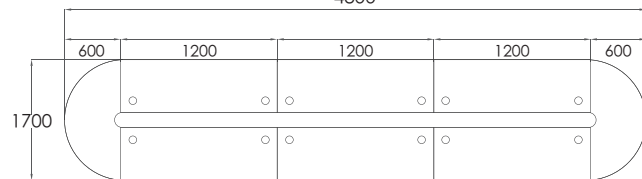

W4800 X D1700 X H760

**5400**

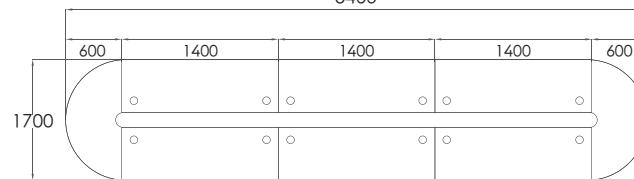

W5400 X D1700 X H760

**6000**

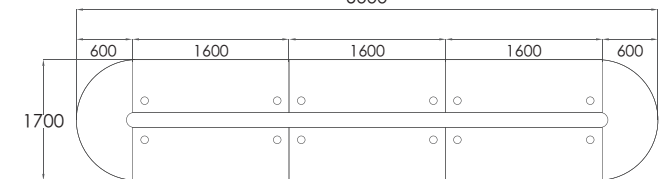

W6000 X D1700 X H760

**TECHNICAL SPECIFICATION**

- TOP SURFACE : 25mm thk melamine laminated chipboard in cherry color
- TABLE LEG : MDF leg
- MODESTY : MDF
- EDGING : 2mm thk PVC

COLOR OPTION :



BLACK CHERRY

\* ALL DIMENSIONS IN MM

**BEEMAG**  
SERIES

OFFICE DESKS





**SIDE CABINET : W1000 X D450 X H760**

**SIDE CABINET**



**OPTIONAL FIXED PEDESTAL**



**TECHNICAL SPECIFICATION**

TOP SURFACE : 25mm thk melamine laminated chipboard in optional colors  
 TABLE LEG : MDF leg  
 MODESTY : MDF  
 EDGING : 2mm thk PVC

COLOR OPTIONS :

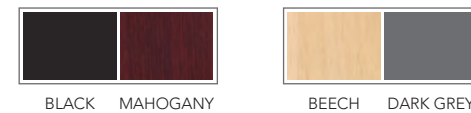

BLACK MAHOGANY

BEECH DARK GREY

\* ALL DIMENSIONS IN MM

**BEEMAG**  
SERIES

OFFICE DESKS





**SIDE CABINET : W1000 X D450 X H760**

**SIDE CABINET**



**OPTIONAL A4 SIZE PAPER RACK**



**TECHNICAL SPECIFICATION**

TOP SURFACE : 25mm thk melamine laminated chipboard in optional colors  
 TABLE LEG : MDF leg  
 MODESTY : MDF  
 EDGING : 2mm thk PVC

COLOR OPTIONS :

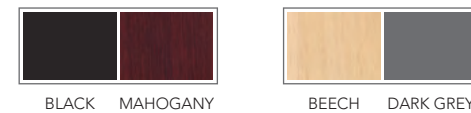

BLACK MAHOGANY

BEECH DARK GREY

\* ALL DIMENSIONS IN MM

**BEEMAG**  
SERIES

MEETING TABLES



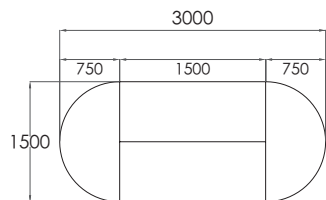

W3000 X D1500 X H760

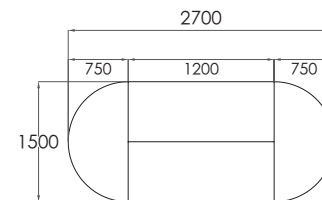

W2700 X D1500 X H760

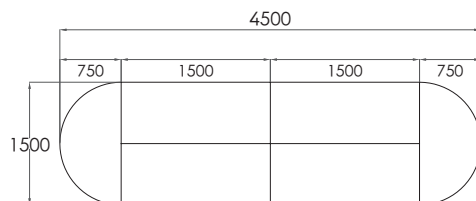

W4500 X D1500 X H760

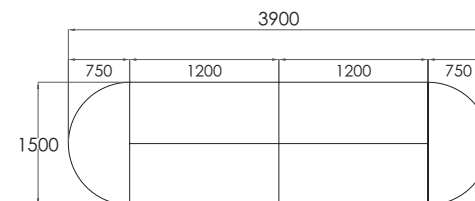

W3900 X D1500 X H760

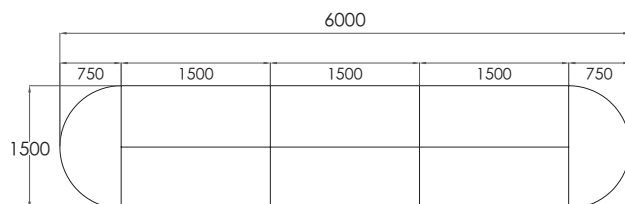

W6000 X D1500 X H760

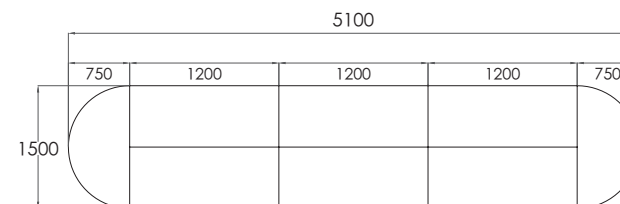

W5100 X D1500 X H760

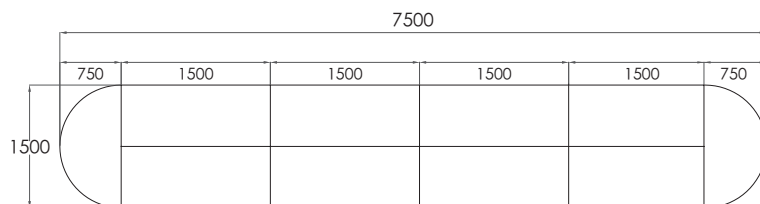

W7500 X D1500 X H760

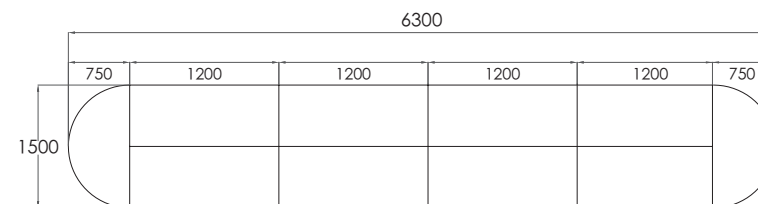

W6300 X D1500 X H760

### TECHNICAL SPECIFICATION

- TOP SURFACE : 25mm thk melamine laminated chipboard in optional colors
- TABLE LEG : MDF leg
- MODESTY : MDF
- EDGING : 2mm thk PVC

#### COLOR OPTIONS :



\* ALL DIMENSIONS IN MM

**BEEMAG**  
SERIES

MEETING TABLES





W2400 x D1200 x H760



W1200 x D1200 x H760  
W900 x D900 x H760



W1800 x D900 x H760



**TECHNICAL SPECIFICATION**

TOP SURFACE : 25mm thk melamine laminated chipboard in optional colors  
 TABLE LEG : MDF leg  
 MODESTY : MDF  
 EDGING : 2mm thk PVC

COLOR OPTIONS :

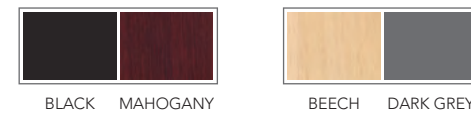

\* ALL DIMENSIONS IN MM

W : OVERALL WIDTH

D : OVERALL DEPTH

H: OVERALL HEIGHT

SW: SEAT WIDTH

SD : SEAT DEPTH

SH : SEAT HEIGHT

BW : BASE WIDTH



**TECHNICAL SPECIFICATION**

- TOP SURFACE : 25mm thk melamine laminated chipboard in optional colors
- TABLE LEG : MDF leg / Steel base
- MODESTY : MDF
- EDGING : 2mm thk PVC

COLOR OPTIONS :



\* ALL DIMENSIONS IN MM



**Writing Table**  
W1200 X D750 X H760  
W1500 X D750 X H760  
W1800 X D750 X H760



**Side Return**  
W1000 X D600 X H760



**Mobile Pedestal**  
W425 X D490 X H540



**Fixed Pedestal**  
W418 X D490 X H480



**Oval Meeting Table**  
W2400 X D1200 X H760  
W1800 X D900 X H760



**Round Meeting Table**  
W1200 X D1200 X H760  
W900 X D900 X H760



**High Half Open Cabinet**  
W800 X D450 X H2000



**High Full Door Cabinet**  
W800 X D450 X H2000



**High Half Glass Cabinet**  
W800 X D450 X H2000



**High Half Open Cabinet**  
W800 X D450 X H2000



**Low Swing Door Cabinet**  
W800 X D450 X H828



**Low Sliding Door Cabinet**  
W800 X D450 X H828



**Low Pigeon Hole Cabinet**  
W800 X D450 X H828



**Low Open Shelf Cabinet**  
W800 X D450 X H828



**Conference Round End**  
W740 X D1480 X H760



**90° Connection Top**  
W750 X D750  
W750 X D450  
W450 X D450  
W600 X D600



**45° Connection Top**  
W750 X D750



**Partition**  
W1500 X D400  
W1200 X D400  
W750 X D400

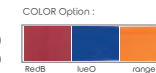

**Counteriser**  
W1500 X D300 X H300

COLOR OPTIONS :



BLACK MAHOGANY

BEECH DARK GREY

\* ALL DIMENSIONS IN MM

W : OVERALL WIDTH

D : OVERALL DEPTH

H: OVERALL HEIGHT

SW: SEAT WIDTH

SD : SEAT DEPTH

SH : SEAT HEIGHT

BW : BASE WIDTH

**L-SHAPE**  
BEEMAG SERIES

WORKSTATION  
CONCEPTS



Don't look at the world with  
your hands in your pockets.  
To write about it you have to  
reach out and touch it.  
- Mark Twain



**L-SHAPE**  
BEEMAG SERIES

WORKSTATION  
CONCEPTS





**L-SHAPE**  
BEEMAG SERIES

WORKSTATION  
CONCEPTS



L-SHAPE 90° ERGONOMIC

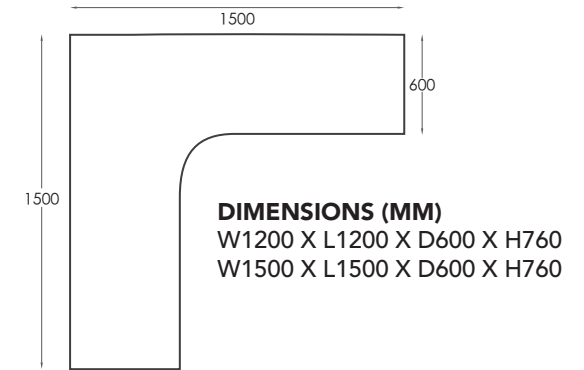

L-SHAPE 120° ERGONOMIC

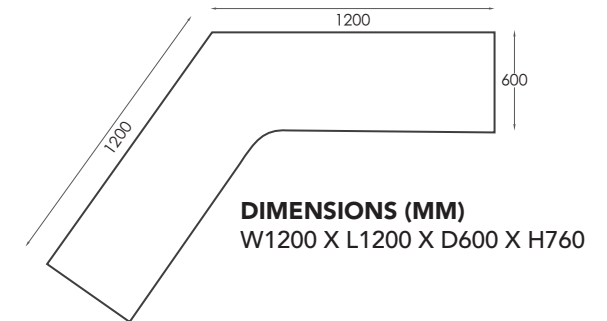

**TECHNICAL SPECIFICATION**

- TOP SURFACE : 25mm thk melamine laminated MDF in mahogany or beech color
- TABLE LEG : Steel & aluminium leg in black or light grey color
- MODESTY : Steel in black or light grey color
- EDGING : 2mm thk PVC

COLOR OPTIONS :



\* ALL DIMENSIONS IN MM



**ZIG - ZAG WORKSTATION**



**2 PAX WORKSTATION**



**PAX WORKSTATION**



**3 PAX WORKSTATION**



**4 PAX WORKSTATION**

COLOR OPTIONS :



\* ALL DIMENSIONS IN MM

W : OVERALL WIDTH

D : OVERALL DEPTH

H: OVERALL HEIGHT

SW: SEAT WIDTH

SD : SEAT DEPTH

SH : SEAT HEIGHT

BW : BASE WIDTH



TABLE WK CUS2316

**DIMENSIONS (MM)**

TABLE WK CUS2316 : W1800 X D600 X H760

TABLE WK BQ13 : W1500 X D1500 X H760



TABLE WK BQ13

**TECHNICAL SPECIFICATION**

TOP SURFACE : 25mm thk melamine laminated MDF in beech color  
 TABLE LEG : Foldable steel leg in black color  
 EDGING : 2mm thk PVC beech color for top surface

COLOR OPTION :



BEECH      BLACK

\* ALL DIMENSIONS IN MM



**DIMENSIONS :** W900 x D400 x H1850

**BASE :** 8.5cm high, thick steel frame used to protect and stabilize the weight of cabinet

**LOCK :** Central Locking System on front doors

**COLOR**

Light Grey

**MATERIAL**

Reinforced case steel construction for lasting durability

0.06cm - 0.1cm thick cold roll steel sheet used before spraying

High quality powder coating, anti rust system

**HANDLE**

Recessed Built-in handle, beautiful and theft proof

- **Handle :** Recessed handles have label holders to identify contents and provide quick access
- **Lock :** Central Locking system on front doors



Mechanical interlock allows only one drawer to open at a time to inhibit tipping

\* ALL DIMENSIONS IN MM



HIGH STEEL GLASS  
SLIDING DOOR CABINET



**DIMENSIONS :** W900 x D400 x H1850

BASE : 8.5cm high, thick steel frame used to protect and stabilize the weight of cabinet

LOCK: Central Locking System on front doors

**COLOR**

Light Grey & Dark Grey

**MATERIAL**

Reinforced case steel construction for lasting durability

0.06cm - 0.1cm thick cold roll steel sheet used before spraying

High quality powder coating, anti rust system

**HANDLE**

Recessed Built-in handle, beautiful and theft proof



\* ALL DIMENSIONS IN MM



**DIMENSIONS :** 4 Drawer : W460 X D620 X H1331 | 2 Drawer : W460 X D620 X H731  
 BASE : 8.5cm high, thick steel frame used to protect and stabilize the weight of cabinet  
 LOCK : Anti - tilt Construction, Central Locking System

**COLOR**  
 Light Grey

**MATERIAL**  
 Reinforced case steel construction for lasting durability  
 0.06cm - 0.1cm thick cold roll steel sheet used before spraying  
 High quality powder coating, anti rust system

○ LOCKS INTRODUCTION



○ INTRODUCE HAND-CLASPING



- ✓ SIMPLE AND ELEGANT
- ✓ SMOOTH SURFACE
- ✓ EASY TO OPERATE

Anti-tilt mechanism just can open one drawer at one time

\* ALL DIMENSIONS IN MM



**5/6 TIER STORAGE RACKS**

**TECHNICAL SPECIFICATION**

---

DIMENSIONS	: W900 x D450 x H2200
TYPE	: Boltless / Skid Mount
MATERIAL	: Steel, Cold Roll Steel
UDL	: 50kg per Shelf
GENERAL USE	: Pallet Racking / Goods Shelf
COLOR	: Dark Grey

---

**TECHNICAL SPECIFICATION**

---

DIMENSIONS	: W1000 x D305 x H2220
TYPE	: Boltless / Skid Mount
MATERIAL	: Steel
UDL	: Up to 40kg
USE	: Library Shelf
COLOR	: Light Grey

---



**LIBRARY SHELVES**

\* ALL DIMENSIONS IN MM



**TECHNICAL SPECIFICATION**

---

DIMENSIONS : W2000 x D500 x H2000  
 TYPE : Boltless / Skid Mount  
 MATERIAL : Steel, Cold Roll Steel  
 UDL : 400kg per Shelf  
 GENERAL USE : Storage / Goods Shelf  
 COLOR : Orange & Blue

---

**TECHNICAL SPECIFICATION**

---

DIMENSIONS : W2400 x D800 x H2000  
 TYPE : Boltless / Skid Mount  
 MATERIAL : Steel, Cold Roll Steel  
 UDL : 2000kg per Shelf  
 GENERAL USE : Storage / Goods Shelf  
 COLOR : Orange & Blue

---



\* ALL DIMENSIONS IN MM

MECHANICAL MOBILE FILING SYSTEM

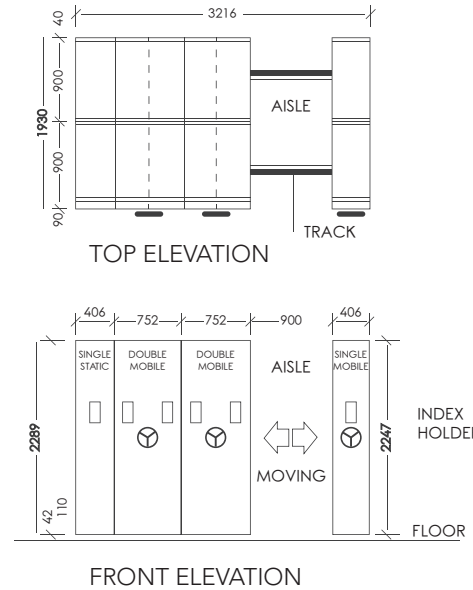

MODEL: L37 - 2M - 40 - TWO BAYS DEEP

Standard Dimensions

Total Height : 2289mm (inclusive trolley height of 110mm)  
 Width Per Bay : 900mm

OPERATED BY STEERING WHEEL MECHANICALLY ASSISTED

Row Type	Depth (mm)	Width (mm)					Height (mm)	No. of Adjustable Shelves per Bay
		2M	3M	4M	5M	6M		
Single Sided Static Bay	406	1930	2830	3730	4630	5530	2289	4
Single Sided Movable Bay	406	1930	2830	3730	4630	5530	2289	4
Double Sided Movable Bay	752	1930	2830	3730	4630	5530	2289	8

\* ALL DIMENSIONS IN MM

**BONGE**  
SERIES

HIGH BACK  
VISITOR





**HIGH BACK**

**DIMENSIONS** | W 720 D 730 H 1140 - 1220



**VISITOR**

W 720 D 730 H 1025

**DESCRIPTION**

- Brilliant craftsmanship creates touch of quality
- Knee tilt mechanism
- Tension control adaptable to body weight
- Seat height adjustment with high quality pneumatic gas lift

**MATERIAL**

High density thick injected molded foam with PU leather finish

**ARMREST**

Fixed arms with cushion padding for comfort

**BASE**

5 Aluminum base, pneumatic steel gas lift

**CASTOR**

Heavy duty double hooded castor tyres

**COLORS**



**PLYWOOD ARMREST**

Fixed plywood armrest with cushion padding for comfort

\* ALL DIMENSIONS IN MM

**NANA**  
SERIES

HIGH BACK  
VISITOR





**HIGH BACK**

**DIMENSIONS** | W 770 D 730 H 1155 - 1255



**VISITOR**

W 770 D 730 H 1020

**DESCRIPTION**

- Brilliant craftsmanship creates touch of quality
- Knee tilt mechanism
- Tension control adaptable to body weight
- Seat height adjustment with high quality pneumatic gas lift

**MATERIAL**

High density thick injected molded foam with PU leather finish

**ARMREST**

Fixed arms with cushion padding for comfort

**BASE**

5 Aluminum base, pneumatic steel gas lift

**CASTOR**

Heavy duty double hooded castor tyres

**COLORS**



BLACK

TAN



**PLYWOOD ARMREST**

Fixed plywood armrest with cushion padding for comfort

\* ALL DIMENSIONS IN MM

**PRESIDENTIAL**  
SERIES

HIGH BACK





**HIGH BACK**

<b>DIMENSIONS</b>	W 680	SW 580
	D 800	SD 550
	H 1200-1280	SH 530 - 600

**MATERIAL**

- Back and seat are made of soft high density thick polyurethane foam.
- CPU with extra padding, finished with fine craftsmanship touch soft PU leather upholstery.
- Multilayer soft pillow design for real comfort.

**ARM REST**

Fixed polypropylene, pp galvanized, Grey color covered with CPU padding high tension.

**BASE**

5 Prong polypropylene base, Pneumatic steel gas lift. Pneumatic 120mm Black Painted Gas Lift.

**COLOR**



BLACK



**RECLINER TILT MECHANISM**  
Swivel tilt movement mechanism



**ARMREST**  
Galvanized PP armrest with Comfortable padding on top

\* ALL DIMENSIONS IN MM

**DEX**  
SERIES

HIGH BACK  
VISITOR





**HIGH BACK**



**VISITOR**

**DIMENSIONS**

W 580	SW 510
D 550	SD 500
H 1180-1260	SH 485-565

W 580	SW 510
D 550	SD 500
H 960	SH 465

**DESCRIPTION**

Back and seat are made of soft high density thick polyurethane foam finished with fine craftsmanship touch soft polyurethane PU leather upholstery

**ARMREST**

Fixed polypropylene

**BASE**

320mm Nylon, 5 Prong

**CASTOR**

50mm diameter nylon castor with black polypropylene wheel

**COLOR**



BLACK



**HEIGHT ADJUSTMENT LEVER**

Height adjustment lever and backrest counter pressure adjustment mechanism

\* ALL DIMENSIONS IN MM

**AERON**  
ORTHOPAEDIC

HIGH BACK





**ADJUSTABLE HEADREST**  
Adjustable headrest for maximum neck support



**FULLY ADJUSTABLE ARMREST**  
Adjustable arms with galvanised padding for comfort



**ADJUSTABLE SEAT**  
Adjustable seat with galvanised padding for comfort



**COAT HANGER**  
Attached coat hanger



**DIMENSIONS**

W 670	D 570	H 940 - 1020
SW 530	SD 510	SH 465 - 535

**COLORS / MATERIAL**

<b>SEAT</b>	<b>BACK</b>	OR	<b>SEAT</b>	<b>BACK</b>
BLACK FABRIC	BLACK MESH		BLACK LEATHER	BLACK LEATHER

\* ALL DIMENSIONS IN MM

**TUNE**  
ORTHOPAEDIC

HIGH BACK





**ADJUSTABLE HEADREST**  
Height adjustable headrest with free-tilting support



**FULLY ADJUSTABLE ARMREST**  
3-way adjustable armrest. The armpad can be move forward or back and swivels into 3 angular positions to allow user to rest arms easily.



**SLIDING SEAT**  
Depth adjustable seat for tension control for back support.



**ADJUSTABLE LUMBAR SUPPORT**  
2-way adjustable lumbar support for 100% back support.



**DIMENSIONS**

W 660	D 700-740	H 900 - 1105
SW 490	SD 440-480	SH 400 - 500

**COLORS / MATERIAL**

<b>SEAT</b> 	<b>SEAT</b> 	<b>SEAT</b> 	<b>BACK</b> 
RED FABRIC	BLUE FABRIC	BLACK FABRIC	BLACK MESH

\* ALL DIMENSIONS IN MM

**RIMOVA**  
ERGONOMIC

HIGH BACK





**RECLINER SYNCHRON MECHANISM**  
 With any position locking, this mechanism provides progressive counter pressure when reclining and personal tension adjustment to suit user individual body weight



**HEADREST**

The headrest is adjustable up and down to provide the ultimate comfort and healthy neck support



**ADJUSTABLE ARMREST**

Height adjustable armrest with PP padding on top provide comfortable resting position for the arms



<b>DIMENSIONS</b>	W 605	D 575	H 1155 - 1255
	SW 510	SD 460	SH 435 - 535

<b>COLORS</b>	SEAT	BACK	OR	SEAT	BACK
	BLACK FABRIC	BLACK MESH		RED FABRIC	BLACK MESH

\* ALL DIMENSIONS IN MM

LEGO  
ERGONOMIC

HIGH BACK





**RECLINER SYNCHRON MECHANISM**

Synchronous leaning multi-functional mechanism lock the back with four positions. Seat sliding adjustment suitable for your body type

**HEADREST**

The headrest is adjustable up and down to provide the ultimate comfort and healthy neck support



**ADJUSTABLE ARMREST**

- Armrest up & down adjustment
- Pad forward & backward adjustment



**DIMENSIONS**

W 650	D 600	H 1140-1210
SW 510	SD 520	SH 430-500

**COLORS**

<b>SEAT</b>	<b>BACK</b>	OR	<b>SEAT</b>	<b>BACK</b>
BLACK FABRIC	YELLOW POLY MESH		BLACK FABRIC	BLACK POLY MESH

\* ALL DIMENSIONS IN MM

**LONG**  
ERGONOMIC

HIGH BACK





**HIGH BACK**

<b>DIMENSIONS</b>	W 650	SW 510
	D 645	SD 510
	H 1195 - 1270	SH 420 - 500

**DESCRIPTION**

- The plain elegant cast gives away tenderness and sensibility
- Swivel tilt movement mechanism, lockable at any position
- Tension control adaptable to body weight
- Seat height adjustment with high quality pneumatic gas lift

**MATERIAL**



High density thick polyurethane foam, fabric and mesh back

**ARMREST**

Big & elegant adjustable armrest with galvanized padding

**BASE**

5 Prong polypropylene base, pneumatic steel gas lift polypropylene wheel

<b>COLORS</b>	<b>SEAT</b>	<b>BACK</b>
	 BLACK FABRIC	 BLACK MESH



**ADJUSTABLE ARMREST**  
Adjustable arms with padding for comfort



**LUMBAR SUPPORT**  
Lumbar support up and down



**COAT HANGER**  
Attached coat hanger

\* ALL DIMENSIONS IN MM

**DELUXE**  
ERGONOMIC

HIGH BACK  
VISITOR





**HIGH BACK**



**VISITOR**

**DIMENSIONS**

W 660	SW 510
D 615	SD 510
H 1180-1260	SH 485-565

W 660	SW 510
D 615	SD 510
H 960	SH 465

**DESCRIPTION**

- The plain elegant cast gives away tenderness and sensibility
- Swivel tilt movement mechanism, lockable at any position
- Tension control adaptable to body weight
- Seat height adjustment with high quality pneumatic gas lift

**MATERIAL**

High density thick polyurethane foam, fabric and mesh back

**ARMREST**

Big & elegant adjustable armrest with galvanized padding

**BASE**

5 Prong steel base, pneumatic steel gas lift

**COLORS**

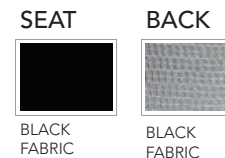

**ADJUSTABLE ARMREST**

Adjustable arms with padding for comfort



**LUMBAR SUPPORT**

Fully adjustable up & down movement with rotational knob for pressure adjustment.



**ADJUSTABLE HEADREST**

Adjustable headrest for maximum neck support.

\* ALL DIMENSIONS IN MM

**MARA**  
ERGONOMIC

HIGH BACK  
MEDIUM BACK  
VISITORS





**HIGH BACK**



**MEDIUM BACK**



**VISITORS**

**DESCRIPTION**

- Modern & elegant design with ergonomics in mind.
- Swivel tilt movement mechanism, lockable at any position
- Tension control adaptable to body weight
- Seat height adjustment with high quality pneumatic gas lift

**MATERIAL**

High density thick molded foam, fabric and mesh back

**ARMREST**

Adjustable armrest with galvanized padding for comfort.

**BASE**

5 Prong polypropylene base, pneumatic steel gas lift polypropylene wheel

**COLORS**

**SEAT**



BLACK FABRIC

**BACK**



BLACK MESH

DIMENSIONS	W 640	SW 510	W 640	SW 510	W 640	SW 510
D 620	D 620	SD 500	D 620	SD 500	D 620	SD 500
H 1160 - 1250	H 1160 - 1250	SH 430 - 535	H 1160 - 1250	SH 430 - 535	H 950	SH 430



**ADJUSTABLE ARMREST**

Adjustable arms with padding for comfort



**MOLDED FOAM**

High density molded foam which retains its density for 5 years

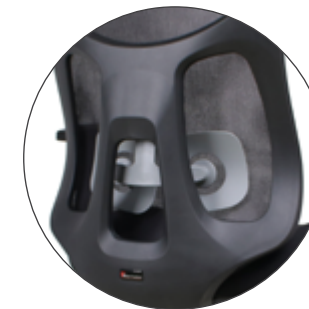

**LUMBAR SUPPORT**

Lumbar support up and down

\* ALL DIMENSIONS IN MM

**SUPREMO**  
SERIES

MEDIUM BACK





**DESCRIPTION**

- A simple and excelent design with simplicity to reveal modern look.
- Swivel tilt movement mechanism.
- Tension control adaptable to body weight.
- Seat height adjustment with high quality pneumatic gas lift.

**MATERIAL**

High quality and high density pure leather

**BASE**

5 Steel base, pneumatic steel gas lift polypropylene Wheel

**COLORS**

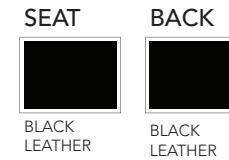

**DIMENSIONS**

W 570	SW 520
D 560	SD 460
H 800 - 890	SH 410 - 500



**FIXED ARMREST**

Stylish & elegant fixed steel armrest



**PURE LEATHER**

High density and high quality pure leather

\* ALL DIMENSIONS IN MM

**VOGUE**  
SERIES

LOW BACK  
VISITOR  
COUNTER





**LOW BACK**



**VISITOR**



**COUNTER**

**DIMENSIONS**

W 590	SW 490
D 580	SD 490
H 910-1000	SH 475-555

W 595	SW 490
D 570	SD 490
H 925	SH 455

W 595	SW 490
D 570	SD 490
H 1200-1400	SH 700-950



**EPOXY ARMREST**

Big & elegant armrest with galvanized PP

**DESCRIPTION**

- Material enriched the geometry of visual impression, deduce the style of modern fashion.
- Swivel tilt movement mechanism.
- Seat height adjustment with high quality pneumatic gas lift.

**MATERIAL**

High density thick polyurethane foam, fabric and mesh back.

**BASE**

5 Prong polypropylene base, pneumatic steel gas lift.

**COLORS**

SEAT	BACK		
BLACK FABRIC	RED MESH	BLUE MESH	BLACK MESH

\* ALL DIMENSIONS IN MM

**ACCENT**  
SERIES

VISITOR CHAIR





**B 01**

W 580  
D 660  
H 960



**B 26**

W 570  
D 640  
H 910



**B 47**

W 560  
D 690  
H 950



**B 56**

W 580  
D 770  
H 1010

DIMENSIONS

**MATERIAL**

- The frame is made of metal with chrome finish for extra support and durability.
- Back and seat are made of high density molded foam.

**BACK AND SEAT COVER**

PVC Leather

**COLOR**



BLACK

\* ALL DIMENSIONS IN MM

**BENO**  
SERIES

STUDENT CHAIR



**DESCRIPTION**

- The plain elegant cast gives away tenderness and sensibility.
- Optional rotating tablet.
- Easy stackable for easy storage.

**MATERIAL**

High density thick polyurethane foam, fabric.

**ARMREST**

Elegant fixed armrest with galvanized padding.

**BASE**

Metal tubing legs with optional castor tyres or fixed studs



**DETACHABLE WRITING TABLET**

Removable writing tablet which can support weight upto 20kg



**STACKABLE**  
Easy stackable for easy storage

<b>DIMENSIONS</b>	W 570	SW 520
	D 560	SD 560
	H 800	SH 450

<b>COLORS</b>	<b>SEAT</b>	<b>BACK</b>
		
	BLACK FABRIC	DARK GREY POLY MESH

\* ALL DIMENSIONS IN MM

**BUMA**  
SERIES

VISITOR CHAIR





**BM 01**



**BM 02**



**BM 03**

**DIMENSIONS**

W 550  
D 500  
H 800

W 435  
D 415  
H 760

W 520  
D 525  
H 865

**MATERIAL**

- The frame is made of spray iron plated steel for extra support and durability.
- Back and seat are made of high density molded foam.

**BACK AND SEAT COVER**

PU Leather / Fabric / PVC

**COLOR**



BLACK



\* ALL DIMENSIONS IN MM

**MAX**  
SERIES

BANQUET CHAIR





**DIMENSIONS** | W 445  
H 980

**MATERIAL**

- 50% Polyester, 50% Cotton.
- Back and seat are made of soft high density thick polyurethane foam.

**FOAM**

40 mm moulded foam with high density fabric (50kg/m<sup>3</sup>).

**FRAME**

Square tube of 25 x 25 x 1.2 mm thick with gold painting.

**COLORS**

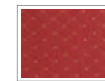

RED DOTTED

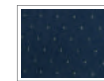

BLUE DOTTED

**STACKABLE**

Easy stackable for easy storage



\* ALL DIMENSIONS IN MM

**NEVO**  
SERIES

WAITING BENCH





**SJ820GA**



**SJ820G BLACK**



**SJ820G SILVER**

**DIMENSIONS**

W1800 x D680 x H770

**SEAT & BACK**

1.5mm thickness Steel  
Optional : PU Padded foam

**ARMS AND LEG**

Chrome Finish

**SEAT WIDTH**

520mm

\* ALL DIMENSIONS IN MM

# LOCATE US

## ARUSHA (HEAD OFFICE)

---

### Main Showroom

Arusha City Complex  
2nd Floor, (Above Bank ABC),  
Swahili Street.

### Showroom 2

Home Comfort,  
Next to Tropicana,  
Swahili Street.

### Showroom 3

AIM Mall, 1st floor,  
Above Village Supermarket,  
Majengo.

---

Office: +255 27 254 6201 | Mobile: +255 683 900 365 | Emails: sales@homecomfort.co.tz

## MWANZA BRANCH

---

### Showroom

Kenyatta Road,  
Opp. NMB Bank, Mwanza.

---

O: +255 28 254 1158  
M: +255 767 835 566  
E: azhar@homecomfort.co.tz

## TANGA BRANCH

---

### Showroom

Market Street,  
Next to TRA Office, Tanga.

---

O: +255 27 264 2221  
M: +255 683 900 365  
E: sales@homecomfort.co.tz



w w w . h o m e c o m f o r t . c o . t z